

1 2 3 4 5 6 7 8

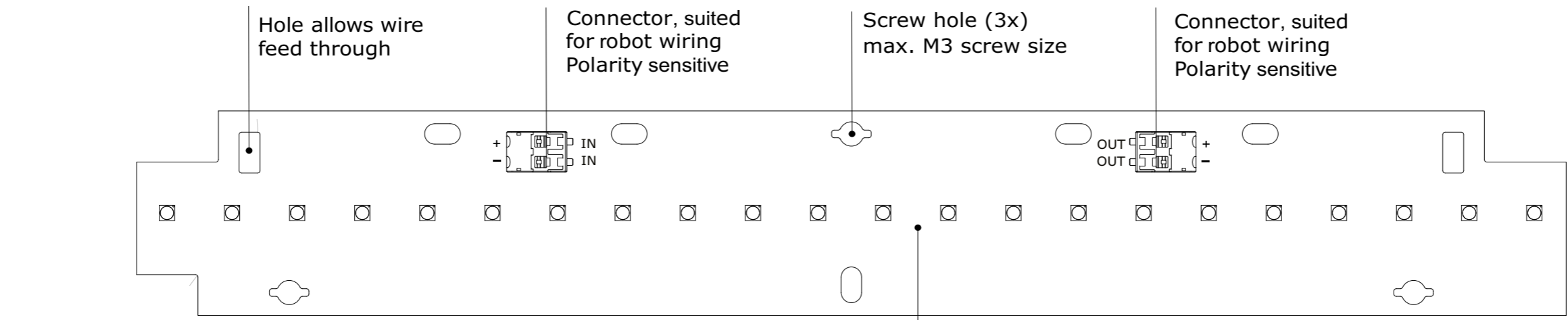

C (2 : 1) (3x)

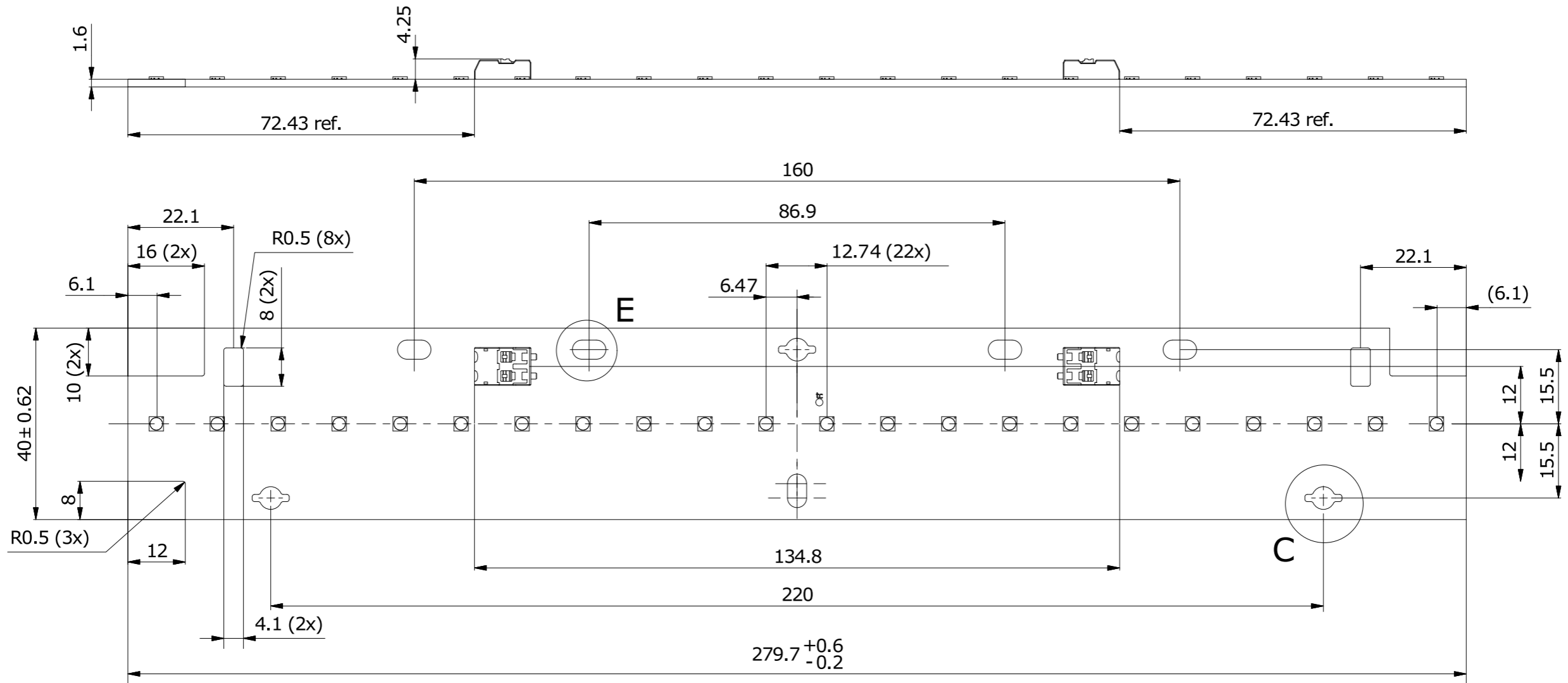
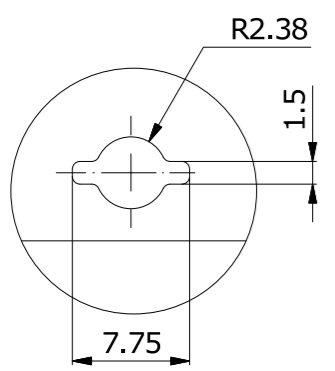

E (2 : 1)

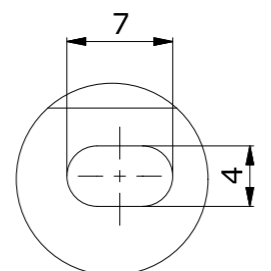

2D file available: Linear LED Strip 1ft 15848P302D80 2019-11-23

TOLERANCES UNLESS OTHERWISE STATED		PCB METAL	AL	Type	15848P302D80	
<200 m	±0.20 mm	PCB THICKNESS	1.6mm	NUMBER	15848	
≥ 200 mm <400 m	±0.25 mm	COPPER THICKNESS	1 OZ	APPROVER	BELLUM	
≥ 400 mm <600 m	±0.30 mm	SURFACE	OSP	ASSESSOR	CELIO	
≥ 600 mm	±0.40 mm	SOLDERMASK	WHITE	DESIGNER	JOSE	
SCALE	1:1	VERSION NO.	V1.5	MANKUN ELECTRONIC CO.,LTD.		